

BONGSHIN[®]



OPERATIONAL MANUAL



BS-270

LOAD LIMITER

CONTENTS

INTRODUCTIONS	2
FEATURES	3
TECHNICAL SPECIFICATION . .	4
DIMENSIONS	5
FRONT PANEL	6
CONNECTION	8
CALIBRATION MODE	11
ZERO CALIBRATION	18
LOW, HIGH SET	20
SERIAL INTERFACE	23
Analog output (Option)	25
Error Message and Trouble Shooting	30

INTRODUCTIONS

1. INTRODUCTION

Thank you very much for your purchasing BONGSHIN Digital Weighing LOAD LIMITER of **BS-270**.

This Instruction Manual will lead you to use **BS-270** with top reliability, High speed, high accuracy.

BS-270 series are over load limiters for cranes, lifts and elevators and so reliable because of using strain gage type-load cell.

They are easy to install because of their small size and built-in digital monitor. Digital Weighing Indicator amplifying the analog output from a load Cell, converting the analog signal to digital data and then displaying this data

As a weight reading and is designed for flawless performance in your demanding

Before using, It is recommended that you read this manual carefully so you may use this device to its full potential.

2. PRECAUTIONS

- Place the indicator on a flat and stable surface.
- Do not severely press because the light pressing of keys can incite the operation.
- Do not subject the scale to sudden temperature changes.
Operating temperature : $-10^{\circ}\text{C}\sim+40^{\circ}\text{C}$
- Keep the scale away from strong EMI noises may cause incorrect weight readings.
- Keep the main body from rain and keep in dry area.
- Do not use inflammable materials in cleaning.

FEATURES

1. Features

- Dual set points relay output.
- 5 digit high brightness LED display.
- Wall mount type enclosure (splash proof)
- Appropriate for weight and measurement system.
- Easy operation and various options.
- Simple full digital calibration.
- Watchdog circuitry (system restoration)
- Weight Back-up (power on actual weight)

2. Main Function

- RS-232C standard
- User can set the max. weight which users want to and division at one's disposal.

TECHNICAL SPECIFICATION

Analog signal Input range	+1mV ~ +34mV	
Non-linearity	0.01% F.S. max.	
Max. Display resolution	1/10,000	
Min. Input sensitivity	0.3 μ V/Digit	
Temperature Drift	Zero drift : $\pm 0.2 \mu$ V/ $^{\circ}$ C RTI max. Span drift : 20ppm/ $^{\circ}$ C max.	
Load cell Excitation	DC 10V, 300mA 350ohm x 4 load cell	
Input Noise	$\pm 0.3 \mu$ V p.p or less	
Input Impedance	10 $M\Omega$ (Min.)	
A/D converter	24bit Sigma-Delta system	
A/D internal resolution	Approximately 200,000 counts	
A/D conversion speed	10 times/sec	
Display	7 Segment LED, 5 Digits, 13mm(Height)	
Polarity indication(-)	"-" minus sign	
Annunciators	Low(Alarm), High(Overload)	
Display increments	1, 2, 5, 10, 20, 50 selectable	
Decimal Points	Selectable to any points	
Operating Voltage	AC 110/220V, 50/60Hz	
Power consumption	Approx. 10 VA	
Operating temperature	-10 $^{\circ}$ C ~ +40 $^{\circ}$ C	
Output	Standard	RS-232C serial output
	Options	1) DC 0~10V (Voltage output) 2) DC 4~20mA (Current output)
Weight	Approx. 3.0kg	

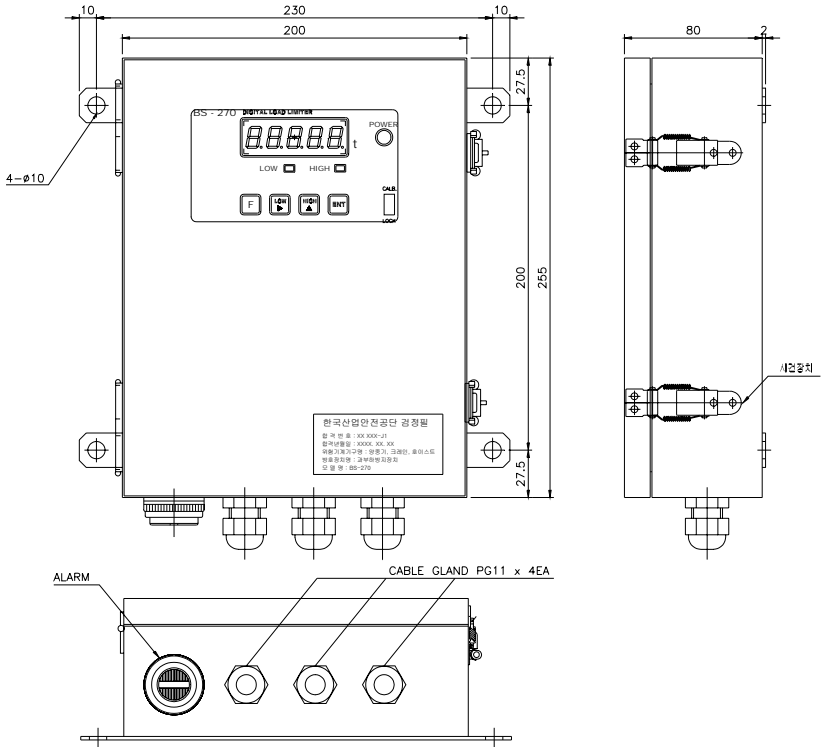

DIMENSIONS

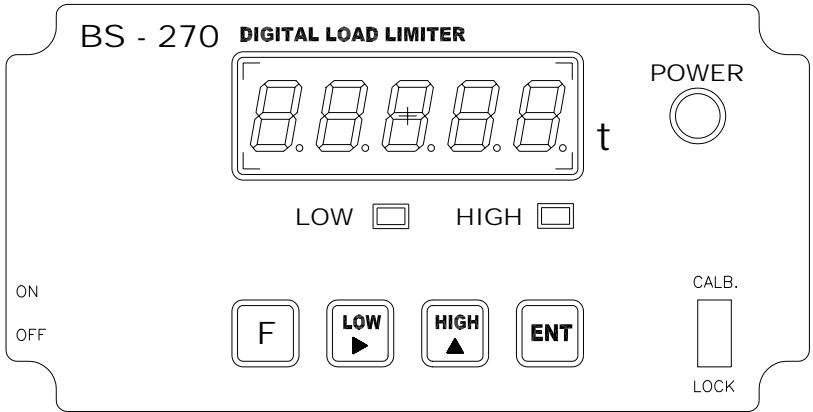

Front Panel



1. Display Lamp ()

-  **LOW lamp** : It will lamp when 1st set point(LOW) control works.
-  **HIGH lamp** : It will lamp when 2nd set point(HIGH) control works.

2. Keyboard



Change the digit of the set value.

Move to the right by 1 place.

Usage—input the numeric value in CAL mode.



Available keys instead of numeric keys.

Change the set value

Increases the first place value to 1.



■ **CAL mode** : Switch to select one of the modes cycles.



■ **CAL mode** :

Change the digit of the set value.

Move to the right by 1 place.

■ **LOCK mode** : LOW Relay Range identify.



■ **CAL mode** :

Available keys instead of numeric keys.

Change the set value

Increases the first place value to 1.

■ **LOCK mode** : HIGH Relay Range identify.



■ **CAL mode** : Store current condition and exit.

■ **ON, OFF** : POWER ON, OFF

■ **Dip slide switch** : CALIBRATION mode

SW ON : Shift to calibration mode.

Turn sw off after calibration, It returns to weighing mode.

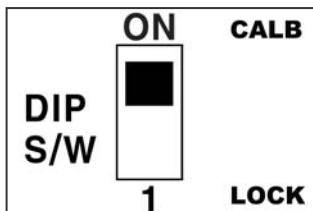

CONNECTION

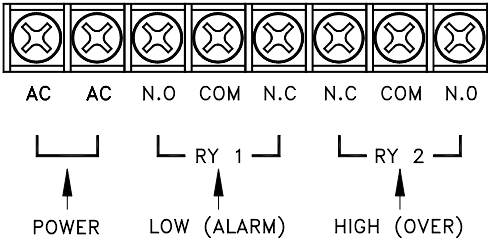

■ **AC IN** : Available to change AC110/220V with multiple.

Before setting up, please confirm the power voltage.

Please change the connect terminal of 110V/220V after opening the cover

If you need to change. (It was settled with AC220V at the first)

Use a stable power supply AC110/220V $\pm 10\%$, 50/60Hz

FUSE : Please use the standard approved .

FUSE AC250V, 0.5A (a glass tube with small type)

■ **OUT-PUT** : N.O, COM, N.C(LOW) / N.C, COM, N.O(HIGH)

Connect between COM terminal and N.O/N.C terminal

With the earth of no electric power.

Please use the output data For a signal only, don't use it for working.

Max earth capacity : AC250V / 0.5A

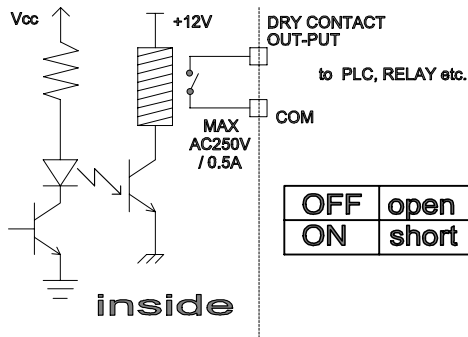

- **LOAD CELL** : Please connect the indicator connector with the wire of load cell according to the color.



SHLD EXC- SIG- SIG+ EXC+



↑
LOAD CELL

Pin no.	SIGNAL	
1	SHLD	SHIELD
2	EXC-	Load cell Input Voltage (-) : EXC- (white)
3	SIG-	Load cell output (-) : SIG- (blue)
4	SIG+	Load cell output (+) : SIG+ (green)
5	EXC+	Load cell Input Voltage (+) : EXC+ (red)

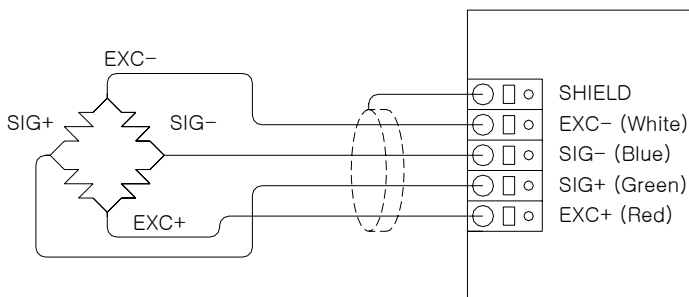

- ※ Because wire color may be different according to a manufacture and load cell models. Please refer for the data sheet of load cell.

The wire color of load cell according to a manufactures.

	1	2	3	4	5
	SHIELD	EXC-	SIG-	SIG+	EXC+
BONGSHIN	SHIELD	WHITE	BLUE	GREEN	RED
CAS, TMI, AND	SHIELD	WHITE	BLUE	GREEN	RED
BLH	YELLOW	BLACK	RED	WHITE	GREEN
INTERFACE	SHIELD	BLACK	WHITE	GREEN	RED
KYOWA	SHIELD	BLACK	WHITE	GREEN	RED
P.T.	SHIELD	BLACK	WHITE	GREEN	RED
SHOWA	SHIELD	BLUE	BLACK	WHITE	RED
SHINKOH	SHIELD	BLACK	WHITE	GREEN	RED
TML	SHIELD	BLACK	GREEN	WHITE	RED
TFAC	YELLOW	BLUE	BLACK	WHITE	RED
HUNTLEIGH	SHIELD	BLACK	WHITE	RED	GREEN

- **RS-232C Port (Standard)** : Serial interface port.
(computer, printer)

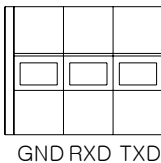

- **Analog Output (Option)** : Analog Output 0 ~10V, 4~20mA
(PLC Interface)

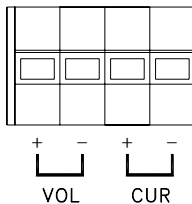



Calibration mode

1. How to enter CAL mode

Slid switch usage

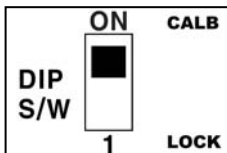
■ Dip slide SW CALB. – CALIBRATION Mode



Pressing  the key and set mode start.

2. Key Usage



■ **CAL mode** : Switch to select one of the modes cycles.



■ **CAL mode** :

Change the digit of the set value.

Move to the right by 1 place.



■ **CAL mode** :

Available keys instead of numeric keys.

Change the set value

Increases the first place value to 1.



■ **CAL mode** : Store current condition and exit.

3. Calibration Menu (Step 1 ~ Step 8)

- Step 1 : Minimum Division Set
- Step 2 : Zero Calibration
- Step 3 : Decimal Point Adjustment
- Step 4 : Setting Weight in span calibration
- Step 5 : Maximum Capacity Set
- Step 6 : LOW(Alarm) Weight Set
- Step 7 : HIGH(Overload) Weight Set
- Step 8 : END

■ Step 1

– Function : **Minimum Division Set**

Range → 1, 2, 5, 10, 20, 50





A step to set up a division value.

"15" means "Division" and "xx" means a division capable of displaying.

Also this value will be displayed as 1-2-5-10-20-50 by each key.

A step to set up a Decimal point is Function mode.

So, it will be go to the next step recording the position.



Key	Display	Description
 : mode	15. 1	0.01 ton (Decimal point :0.00)
 :move into		1 : 1,2,3,4,5…
 : increase		2 : 2,4,6,8,10…
 : Store and move into next menu		5 : 5,10,15,20,25… 10 : 10,20,30,40,50… 20 : 20,40,60,80,100… 50 : 50,100,150,200,250…

☞ REF 1. The minimum division means the value of one division.

☞ REF 2. External resolution is obtained by division the min. division by the maximum capacity. Set the resolution to be within 1/10,000.

■ Step 2





– Function : **Zero Calibration**

Key	Display	Description
 Zero calibration and move into next menu		Unload the tray and press “ENT” key Under zero calibration Zero calibration is completed.

☞ REF 1. If zero calibration is done without any error, “18888” message is displayed and program moves into Step 3 automatically.

■ Step 3







– Function : **Decimal Point Adjustment**

Key	Display	Description
 : move into  : Shift of decimal point  : Store and move into next menu		18888 : 0 1888.8 : 0.0 188.88 : 0.00 18.888 : 0.000 1.8888 : 0.0000

■ Step 4

- Function : **Setting Weight In Span Calibration**

Range → 1~ 99,999

Key	Display	Description
 : move into  : Increase  : Shift of digit  : Store and move into next menu		Setting Weight 20.00ton Load the weight which was set in and press "ENT" key. Under span calibration Example : 20.00 ton setting  5.00 ton setting 

☞ REF 1. The weight shall be within the range of 10%~100% of maximum weight.





☞ REF 2. The setting weight must be over the range of 10% of maximum weight.

☞ REF 3. The setting weight over the maximum capacity.

■ Step 5

– Function : **Maximum Capacity Set**

Range → 1 ~ 99,999





Key	Display	Description
 : move into  : Increase  : Shift of digit  : Store and move into next menu		Maximum capacity 20.00 ton

☞ REF 1. The maximum capacity means the maximum weight that scale can measure.

■ Step 6

– Function : **LOW (Alarm) weight Set**





Range → 1 ~ 99,999

Key	Display	Description
 : move into  : Increase  : Shift of digit  : Store and move into next menu		LOW(Alarm) weight set 20.00 ton

■ Step 7

– Function : **HIGH (Overload) weight Set**

Range → 1 ~ 99,999

Key	Display	Description
 : move into  : Increase  : Shift of digit  : Store and move into next menu		HIGH(Overload) weight set 22.00 ton



■ Step 8

– Function : **END**

The "Good" message is displayed in 8 step,
 all span adjustment is end.

Press “ENT” key after put down of span standard weight on the crane.

The indicator will enter into user's weighing mode.

Key	Display	Description
 : Store and move into weighing mode		END

4. How to enter Weighing mode

Slid switch usage

- Dip slide SW LOCK – Weighing Mode

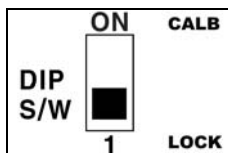

ZERO Calibration

1. How to enter CAL mode

Slid switch usage

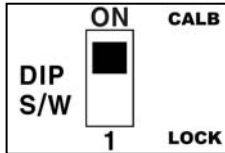

■ Dip slide SW CALB. – CALIBRATION Mode



Pressing  the key and set mode start.

2. ZERO Calibration

■ Step 1

Key	Display	Description
 : mode  : Zero calibration and move into next menu		Each times are press the “F” mode key which is changed preset conditions as followed. Unload the tray and press “ENT” key Under zero calibration Zero calibration is completed.



REF 1. If zero calibration is done without any error, “18888” message is displayed and program moves into Step 1 automatically.

■ Step 2

– Function : **END**

The "Good" message is displayed in 2 step,
all zero adjustment is end.

The indicator will enter into user's weighing mode.

Key	Display	Description
 : mode		Each times are press the "F" mode key which is changed preset conditions as followed. END
 : Store and move into weighing mode		

3. How to enter Weighing mode

Slid switch usage

■ Dip slide SW LOCK – Weighing Mode

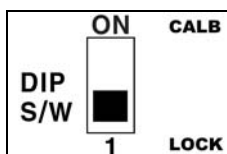



LOW(Alarm), HIGH(Overload) SET

1. How to enter CAL mode

Slid switch usage

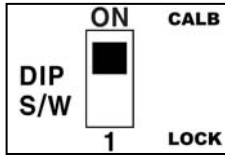





■ Dip slide SW CALB. – CALIBRATION Mode



Pressing  the key and set mode start.

2. LOW (Alarm) weight setting







Range → 1 ~ 99,999

Key	Display	Description
 : mode		Each times are press the “F” mode key which is changed preset conditions as followed.
 : move into		
 : Increase		
 : Shift of digit		
 : Store and move into next menu		
		LOW(Alarm) weight set 20.00 ton

REF 1. LOW(Alarm) weight \leq HIGH(Overload) weight

3. HIGH (Overload) weight setting

Range → 1 ~ 99,999

Key	Display	Description
 : mode		Each times are press the "F" mode key which is changed preset conditions as followed. HIGH(Overload) weight set 22.00 ton
 : move into		
 : Increase		
 : Shift of digit		
 : Store and move into next menu		

☞ REF 1. LOW(Alarm) weight \leq HIGH(Overload) weight



4. How to enter Weighing mode

– Function : **END**

The "Good" message is displayed, all relay adjustment is end.

Press "ENT" key after put down of span standard weight on the crane.

The indicator will enter into user's weighing mode.

Key	Display	Description
 : mode  : Store and move into weighing mode		Each times are press the “F” mode key which is changed preset conditions as followed. END

Slid switch usage

■ **Dip slide SW LOCK – Weighing Mode**

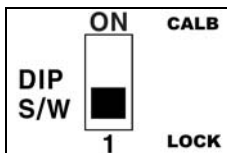

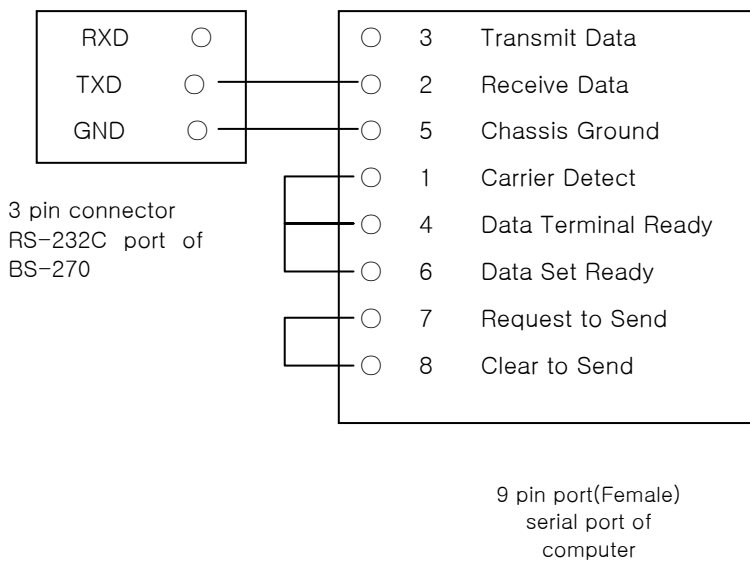
► RS-232C port connection

Analog output (option)

1. Voltage (0~10V) Analog Output

- * The voltage output occurs proportionally the voltage according to the size of a weight
In 0V ~10V.

■ SPECIFICATION

output Voltage	0 ~ 10V DC out
Precision	Max 1/1000
Min Impedance	Over 1 kΩ

■ Analog Out Standard Weight Selecting.

Analog max out value when weight setup.

The indicator will enter into user's CALB mode.

Slid switch usage

■ Dip slide SW CALB. – CALIBRATION Mode

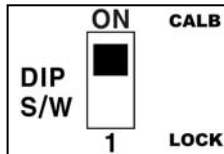





Pressing  the key and set mode start.

Dip slide sw : CALB mode

SW ON (up) : Shift to CALB mode. (calibration mode)

■ Maximum Capacity set

Range → 1 ~ 99,999

Key	Display	Description
 : move into  : Increase  : Shift of digit  : Store and move into next menu		Maximum capacity 20.00 ton example) 0.00 ton----→ 0V 20.00 ton----→ 10V

REF 1. The maximum capacity means the maximum weight that scale can measure.

■ Adjustment



- * The voltage out is to 0V when the weight is displayed 0 kg in indicator.
- * The voltage out is to 10V when the weight is displayed max. capacity in indicator.
- * If analog output is not correct,
 You can make a fine adjustment with “ZERO” VR(Zero adjustment) and “GAIN” VR(Span adjustment)
 on analog pc board by multi meter.
 (Recommended accuracy : 1/1,000)

2. Electric current (4~20mA) Analog Output

- * The voltage output occurs proportionally the voltage according to the size of a weight
In 4mA ~20mA.

■ SPECIFICATION

output Voltage	4 ~ 20 mA DC Current out
Precision	Max 1/1000
Min Impedance	Under 500 Ω

■ Analog Out Standard Weight Selecting.

Analog max out value when weight setup.

The indicator will enter into user's CALB mode.

Slid switch usage

■ Dip slide SW CALB. – CALIBRATION Mode

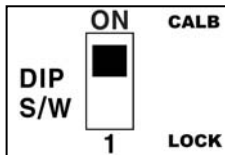





Pressing  the key and set mode start.

Dip slide sw : CALB mode

SW ON (up) : Shift to CALB mode. (calibration mode)

■ Maximum Capacity set

Range → 1 ~ 99,999

Key	Display	Description
 : move into  : Increase  : Shift of digit  : Store and move into next menu		Maximum capacity 20.00 ton example) 0.00 ton → 4 mA 20.00 ton → 20 mA

REF 1. The maximum capacity means the maximum weight that scale can measure.

■ Adjustment



* How to calibrate for output rate between 4mA and 20mA.

The current out is to 4 mA when the weight is displayed 0 kg in indicator.

The current out is to 20 mA when the weight is displayed max. capacity in indicator.

If analog output is not correct,

You can make a fine adjustment with “ZERO” VR(Zero adjustment) and “GAIN” VR(Span adjustment)

On analog pc board by multi meter.



3. How to enter Weighing mode

– Function : **END**

The "Good" message is displayed, all relay adjustment is end.

Press "**ENT**" key after put down of span standard weight on the crane.

The indicator will enter into user's weighing mode.

Key	Display	Description
 : mode		Each times are press the "F" mode key which is changed preset conditions as followed. END
 : Store and move into weighing mode		

Slid switch usage

■ Dip slide SW LOCK – Weighing Mode

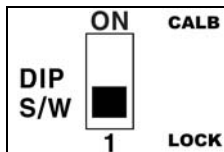

Error Message and Trouble Shooting

ERROR	CAUSE	A/S	Reference.
Waving a weight Value. Appear "no.LC"	① Load cell damage ② Insulation resistance badness of load cell. ③ Weighing part error	① Checking for Input, Output of load cell. Resistance Value. ② Checking Insulation Resistance value of Load cell.	① Input resistance : about 1130Ω ② Output resistance : about 1000Ω ③ Insulation Resistance : over100MΩ
A. Changing a Weight value, B. Not return to ZERO Appear "Ovr " (OVER LOAD)	① Load cell damage.	① Checking Insulation Resistance value of Load cell. (Normal Max 100MΩ or -Ovr-appear)	
	① Disconnected to Load Cell.	① Confirm a connect of Load cell ② Checking a single wire Of load cell cable	
Weight (-) changed Appear "-Ovr " (OVER LOAD)	① Load cell output (SIG+,SIG-)changed.	① Load cell connector	
Appear "Ovr" or "-Ovr "	① Load cell damage ② Connection Error	① Load cell damage ② Load cell connector	
	① Excess Max weight	① Remove excess weight	